

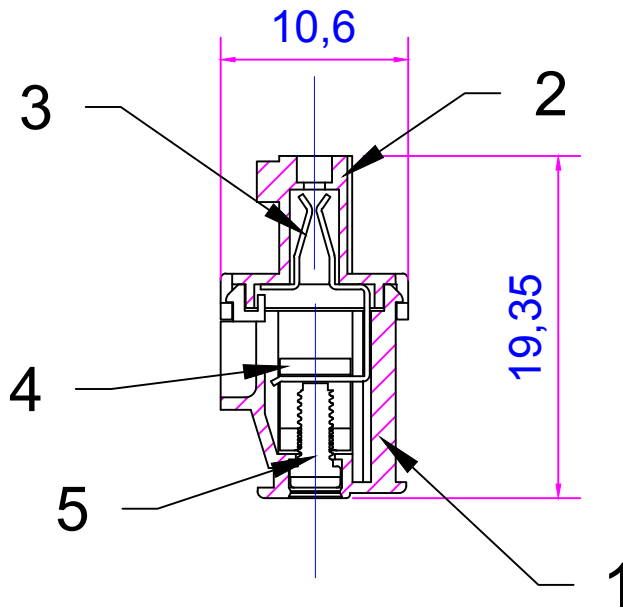

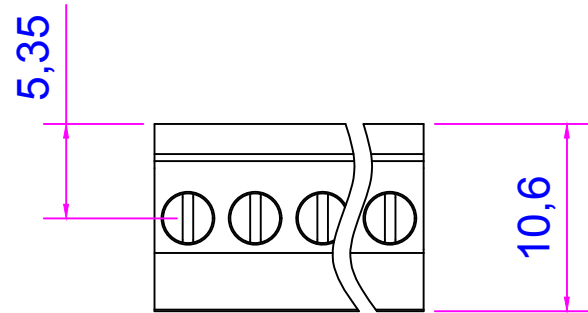

D1RFRD006

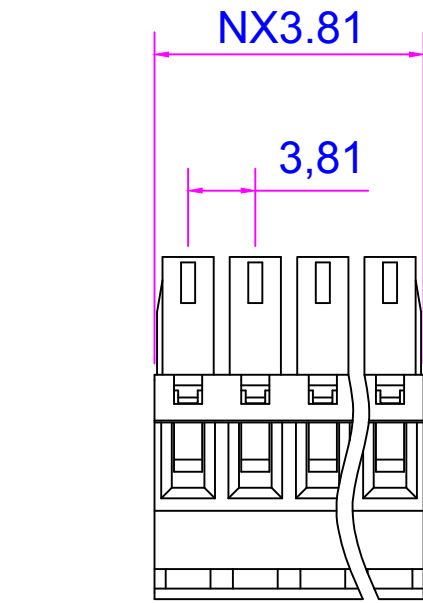
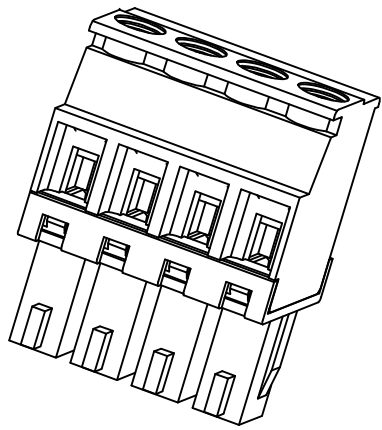

| 序号/RevNO | 名称/Title | 文件编号/FileNO |
|----------|-------------------|-------------|
| 1 | 15EMGKA-3.81 塑件1 | |
| 2 | 15EMGKA-3.81 塑件2 | |
| 3 | 15EMGKA-3.81 夹子 | |
| 4 | 15EMGKA-3.81 方扣 | |
| 5 | 15EMGKA-3.81 一字螺丝 | |

| pitch range in mm | | | Nominal dimension range in mm | | | | | — |
|-------------------|--------|--------|-------------------------------|--------|--------|-------|-------|--|
| to | over | to | to | over | over | over | over |   |
| 6 | 6 | 10 | 30 | 30 | 60 | 100 | 150 | |
| ± 0.10 | ± 0.15 | ± 0.25 | ± 0.20 | ± 0.30 | ± 0.50 | ± 0.7 | ± 1.0 | 0.05/10 |

Poles: 2P/3P-24P
 Pitch: 3.81mm
 Voltage Rating: 300V
 Current Rating: 8A
 Wire range: 28-16AWG
 Housing: PA66(UL 94V-0)
 Wire guard: Phosphor bronze, Ni plated
 Pin header: Brass, Tin Plated
 Screw: M2, Steel(Q235), Zinc Plated
 Torque: 0.2N.m

| | | | | | |
|-----------------|----------------|--|---|---------------------------|-------------|
| 设计/Designed by. | 绘图/Drawing by. | 审核/Checked by. | 批准/Approved by. | 未注公差 General Tolerance | |
| 图名/Title | 文件编号/FileNO | 慈溪市美感电子接插件厂 Cixi Meigan Electric Appliance Socket Factory | | .x ± 0.3 | x° ± 2° |
| 15EMGKA-3.81 | 页序/Sheet | | | .xx ± 0.15 | .xx° ± 0.5° |
| 备注/Remark | 视图/PROJECTION | |  | 单位/Units:mm | |

| 序号/RevNO | 更改记录/Revision note | 签名/Signature | 日期/Date |
|----------|--------------------|--------------|---------|
| 8 | | | |
| 7 | | | |
| 6 | | | |
| 5 | | | |
| 4 | | | |
| 3 | | | |
| 2 | | | |
| 1 | | | |